



**USAID**  
FROM THE AMERICAN PEOPLE



**FEED THE FUTURE**  
The U.S. Government's Global Hunger & Food Security Initiative

# Maize quality standards and specifications

A trainer's manual for smallholder farmers in Tanzania

**Christopher Mutungi, Audifas Gaspar & Adebayo Abass**



# **Maize quality standards and specifications**

A trainer's manual for smallholder farmers in Tanzania

## **Author affiliations**

**Christopher Mutungi**-International Institute of Tropical Agriculture

**Audifas Gaspar**-International Institute of Tropical Agriculture

**Adebayo Abass**-International Institute of Tropical Agriculture

The *Enhancing partnership among Africa RISING, NAFKA, and TUBORESHE CHAKULA Programs for fast tracking delivery and scaling of agricultural technologies in Tanzania* is an interdisciplinary and inter-institutional project that aims to address smallholder farmers' needs in the semi-arid and sub-humid zones of Tanzania. The 3-year project is funded by the USAID Mission in Tanzania as part of the U.S. Government's Feed the Future initiative.

Through participatory and on-farm approaches, candidate technologies are being identified and evaluated for scaling by the project team. This is being achieved through the already established networks by Tanzania Staples Value Chain (NAFAKA), Tuboreshe Chakula (TUBOCHA), and other institutional grassroots organizations, creating an opportunity for mainstreaming into wider rural development programs, beyond Africa RISING's current zones of influence.

The project is led by the International Institute of Tropical Agriculture (IITA) and the USAID Tanzania mission-funded programs NAFKA and TUBOCHA. Developmental activities addressing the project objectives are being implemented in Manyara, Dodoma, Morogoro, Iringa, and Mbeya Regions in Tanzania.

The Project partners appreciate support from the American people delivered through the USAID Feed the Future initiative. We also thank farmers and local partners at all sites for their contributions to the project and the CGIAR system.

© International Institute of Tropical Agriculture, 2020

Citation: Mutungi, C., Gaspar, A. and Abass, A. 2020. *Maize quality standards and specifications: A trainer's manual for smallholder farmers in Tanzania*. Ibadan, Nigeria: IITA.



This document is licensed for use under the Creative Commons Attribution 4.0 International License.

Cover photo credit: Stephanie Malyon/CIAT

Layout and editing: Abel B. Mwalongo

# Table of content

List of tables	i
List of figures	i
List of acronymy	ii
Introduction	1
The benefits of accepting to use maize quality standards	1
Positive impacts of the knowledge and implementation of quality standards	1
Objectives	1
Maize quality parameters	2
General quality specifications	7
Sampling procedure and grading	9
Sampling equipment	9
Obtaining the primary sample	9
Obtaining the test sample	12
Sample analysis	13
Further readings	15

# List of tables

Table 1. Maize Quality Parameters.	2
Table 2. The East African Maize Standards (EAS 2:2013).	7
Table 3. Sample analysis.	10
Table 4. The procedures and parameters for maize sample analysis.	13

# List of figures

Figure 1. Sampling equipment.	9
Figure 2. Different designs of probes used for obtaining sample from the sides of an ordinary bag.	9
Figure 3. A sampling probe for taking sample from the top down the container e.g. from a metal silo.	10
Figure 4. Box sample divider.	12
Figure 5. Quartering method.	12

# List of acronyomy

ACDI/VOCA	Agricultural Cooperative Development International / Volunteers in Overseas Cooperative Assistance
Africa RISING	Africa Research in Sustainable Intensification for the Next Generation
CGIAR	Consortium of International Agricultural Research Centers
FTF	Feed the Future
GDP	Gross Domestic Product
IITA	International Institute of Tropical Agriculture
USAID	United States Agency for International Development

# Introduction

Maize quality standards and specifications are important because they safeguard safety, nutritional value, and the worth of maize in the market. Quality of maize is judged by the overall appearance, and the quality diminishes if some of the grains are damaged by insects or rodents, or are discolored, moldy, broken, or contaminated by non-grain matter of organic or inorganic origin.

## The benefits of accepting to use maize quality standards

- Increased transparency in grain trade. Standards formalize the language of trade, and therefore protect farmers, traders, processors and consumers from exploitation.
- Increased efficiencies that reduce costs, increase competitiveness and create incentives.
  - Farmers who meet quality specifications can get higher prices and longer-term contracts from buyers, which in turn gives them incentive to invest more in production.
  - Processors who buy good quality raw maize are able to eliminate additional costly processing steps and are therefore able to access better markets for their products.

## Positive impacts of the knowledge and implementation of quality standards

- Enhanced food safety by ensuring agreed limits for contaminants such as aflatoxin are adhered to;
- improved nutritional value of products by safeguarding overall produce quality;
- improved trade as producers and buyers can transparently determine the true value of their produce;
- increased productivity because farmers have the incentive to adopt technologies that enable them to produce more efficiently.







## Objectives

This manual is intended to guide extension officers, and other agricultural advisors to offer training targeted at:

- i. Equipping smallholder maize farmers and traders with knowledge of maize quality;
- ii. Empowering maize farmers and traders with techniques of assessing quality of their produce;
- iii. Enabling farmers and traders to take informed quality improvement decisions and therefore be able to cut down on the costs associated with rejection due to poor quality;
- iv. Guiding farmers and traders in the direction of earning better prices by selling and trading in high quality produce;
- v. Guiding farmers, traders, and small processors on how to inspect grain for quality by testing a sample to see if it meets the required standards;
- vi. Equipping smallholder farmers, traders and processors with guidelines for decisions related to grain care, use, and marketing.

# Maize quality parameters

**Table 1.** Maize quality parameters.

Parameter		Description
<b>Clean maize</b>		<p>Dry shelled grain of either dent or flint varieties which may be white, yellow, orange or other non-mixed colors.</p>
<b>Dent maize</b>		<p>Maize whose kernels have a depression in the middle of the crown. The depression is caused by shrinkage of the <u>soft endosperm</u> in the middle part of the kernel. Maize is classified as “dent” if it consists 95% or more of the kernels in a sample have a dent.</p>
<b>Flint maize</b>		<p>Maize whose kernels do not have a depression but instead are entirely round crown. The maize kernels contain a relatively large amount of <u>hard endosperm</u></p>
<b>Yellow maize</b>		<p>Maize that is yellow in color and does not contain more than 5% of other colored grains.</p>
<b>Orange maize</b>		<p>Maize that is orange in colour and does not contain more that 5% of other colored grains.</p>
<b>Purple maize</b>		<p>Maize that is purple in color and does not contain more that 5% of other colored grains.</p>



<p><b>White maize</b></p>		<p>Maize that is white in color and does not contain more than <u>2%</u> of other colored grains.</p>
<p><b>Red-colored maize</b></p>		<p>Maize that is red or maroon in color and does not contain more than 5% of other colored grains.</p>
<p><b>Variogated maize</b></p>		<p>Maize with kernels of different colours on the same cob.</p>
<p><b>Broken grains</b></p>		<p>Fragments of maize grains, which will pass through a 4.5-mm sieve. Usually broken grains that are retained on the 4.5 mm sieve are not considered broken according to the East African Maize standards. Any whole maize that goes through the sieve is considered broken.</p>
<p><b>Foreign matter</b></p>		<p>Any material that is not maize grain which pass through a 4.5 mm screen and other light coarse matter that may be retained on the sieve.</p>
<p><b>Insect damaged maize</b></p>		<p>Maize grains that have been damaged by insects. This includes grains that may have been bored by weevils, have insect webbings or holes, have insects or their larvae inside them, or have insect parts or waste on them.</p>

<p><b>Rodent damaged maize</b></p>		<p>Maize whose germ has been removed by rats and mice. Such maize may also be contaminated with feces, urine and hairs of rats or mice.</p>
<p><b>Insect infested maize</b></p>		<p>Maize with visible live or dead insects.</p>
<p><b>Mixed grains</b></p>		<p>A mixture of maize grains of different natural colors.</p>
<p><b>Other Colored grains</b></p>		<p>Maize grains that have a pericarp of a natural color which differs from the dominant color of a grain lot or sample.</p>
<p><b>Moldy grains</b></p>		<p>Maize grains with visible blue, pink, white, grey or green fungal growth on the tips or surface. Such grains may contain toxins such as aflatoxin and Fumonisin.</p>
<p><b>Discolored grains</b></p>		<p>Maize that has unusual color. The unusual color may be caused by heat damage, fermentation, molds, bad weather, disease or soil. A maize kernel is considered discolored if at least 1/4 of its surface does not have the usual color.</p>

<p><b>Germinated grains</b></p>		<p>Maize grains that have sprouted. Signs of sprouting include bulging, cracked seed coats through which a sprout has emerged or is just beginning to emerge.</p>
<p><b>Rotten/ diseased grains</b></p>		<p>Maize grains that are rotten due to fungi, bacteria or other agents of decay.</p>
<p><b>Shriveled grains</b></p>		<p>Maize grains that are under-developed, thin, shrunken, and papery in appearance.</p>
<p><b>Heat damaged grains</b></p>		<p>Maize that has been damaged by heat caused by fermentation during storage.</p>
<p><b>Filth</b></p>		<p>Impurities of animal origin such as animal waste, dead worms, insects, insect parts, animal hairs or fur, dead skins etc.</p>
<p><b>Organic matter</b></p>		<p>Impurities of plant origin such as leaves, pieces of husks, pieces of cobs, straw or grass.</p>

**Inorganic matter**



Other materials that are not grain and are not of animal or plant origin e.g. stones, soil, balls of mud, sand or gravel, broken glass, nails, plastics or metallic objects.

**Other seeds**

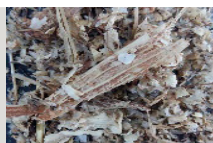

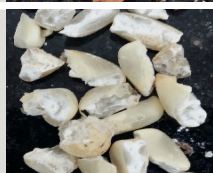


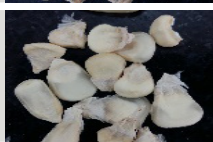







Legume or cereal grains other than maize that are edible such as beans, peas, sorghum, wheat, millet and rice or inedible such as weed seeds.

## General quality specifications

- Good quality maize is free from foreign odors, molds, live or dead pests, rat droppings (feces, urine and hairs) and other injurious contaminants.
- The maize should not contain levels of chemical residues higher than those recommended.
- Grain with musty smell or generally appearing moldy should be rejected.

**Table 2.** The East African Maize Standards. Adapted from EAS 2:2013.

Quality parameter		Maximum limits		
		Grade 1	Grade 2	Grade 3
Foreign matter (g/100g)		0.5	1	1.5
Inorganic matter (g/100g)		0.25	0.5	0.75
Broken kernels (g/100g)		2	4	6
Pest damaged grains (g/100g)		1	3	5
Rotten and diseased grains (g/100g)		2	4	5
Moldy and discolored grains (g/100g)		0.5	1	1.5
Immature or shriveled grains (g/100g)		1	2	3
Filth (g/100g)		0.1	0.1	0.1
Total defective grains (g/100g) <sup>1</sup>		3.2	7	8.5

Moisture contents (g/100g) <sup>2</sup>		13.5
Total Aflatoxin (ppb) <sup>3</sup>		10
Aflatoxin B1 (ppb) <sup>3</sup>		5
Fumonisin (ppb)		2000

Things to note:

1. Total defective grains are not the sum of individual defects but is instead is 70% of the sum of individual defects).
2. Moisture content is ascertained using a moisture meter.
3. Aflatoxin and fumonisin are poisons found in maize that is or was infected by fungus. They cannot be seen. A sample should be taken to a specialized laboratory or similar facility for testing.

# Sampling procedure and grading

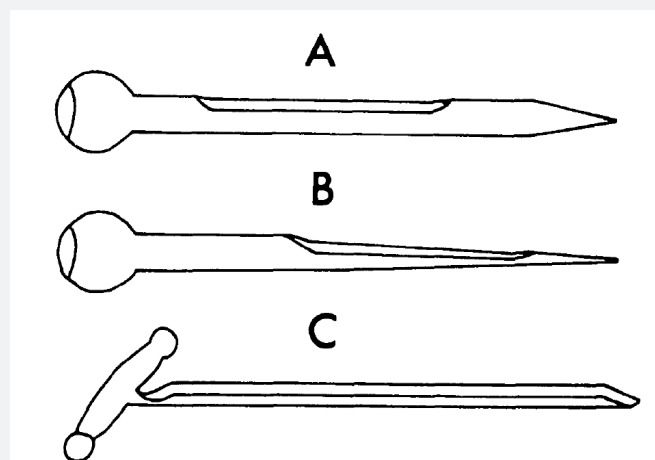
## Sampling equipment



**Figure 1.** Sampling equipment.

## Obtaining the primary sample

- Sampling should be done randomly so that every grain has an equal chance of being picked.
- Usually, a sampling probe (also called sampling spear) is used (See Figure 1 and Figure 2).
- Typical probes are cylindrical in shape. They are 40 – 45 cm long with a diameter of 2.5 cm and a tapered end for piecing into the bag.



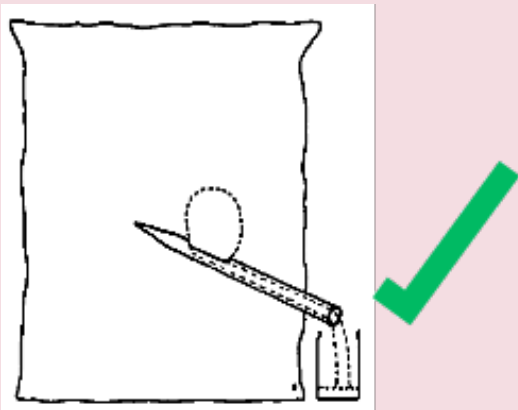
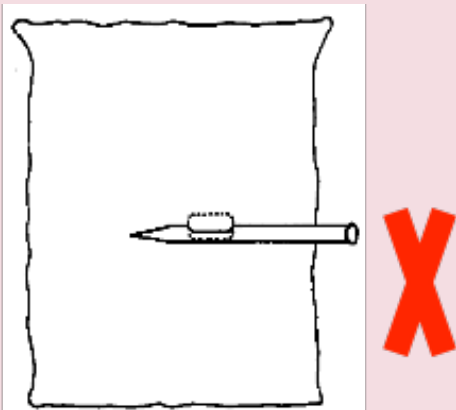
**Figure 2.** Different designs of probes used for obtaining sample from the sides of an ordinary bag.

**Note:** These should not be used on hermetic bags.

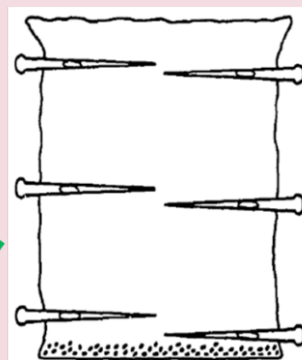
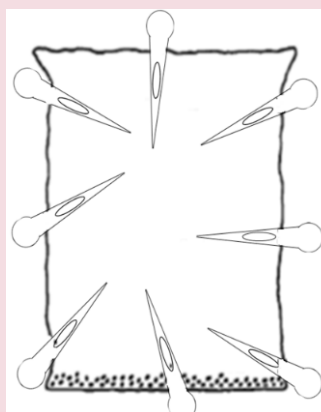


**Figure 3.** A sampling probe for taking sample from the top down the container e.g. from a metal silo.

**Table 3.** How sampling should be done in different situations.

Situation	Method of sampling
Sampling from an ordinary bag	<p>The sampling probe should be inserted from a corner diagonally.</p> <ol style="list-style-type: none"> <li>1. Push the probe into the bag to the required distance, with the open side facing downwards, and at an angle.</li> <li>2. Twist the probe so that the open side is turned upwards in order to collect grain into the channel.</li> <li>3. On withdrawing the probe from the bag, the grain is tipped out into a container.</li> </ol>
	<div style="display: flex; justify-content: space-around; align-items: center;"> <div style="text-align: center;">  </div> <div style="text-align: center;">  </div> </div> <p>Repeat the sampling at least 6 times from different points of the same bag from all four directions so as to obtain a representative sample. Note that a representative sample may not be obtained if sampling is not properly done; e.g. in the illustration below, insects at the bottom of the bag will not be detected if sampling is not done from all sides of the bag.</p>





Sampling from a stack of bags

- If the stack is 10 bags or less, all bags should be sampled.
- If the stack is 10 -100 bags, 10 randomly selected bags should be sampled.

Sampling from a truck

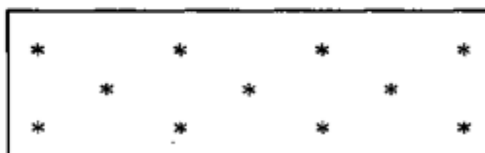
- When sampling from a track the scheme shown below should be used.



Truck containing up to 15 tonnes:  
five sampling points (middle and  
approximately 50 cm from sides).



Truck containing 15 to 30 tonnes:  
eight sampling points.

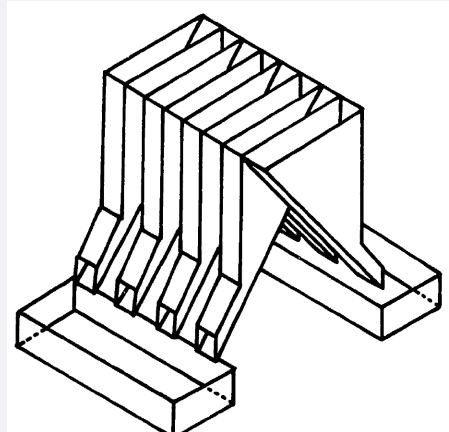


Truck containing 30 to 50 tonnes:  
eleven sampling points.

Source: International Standard ISO 950

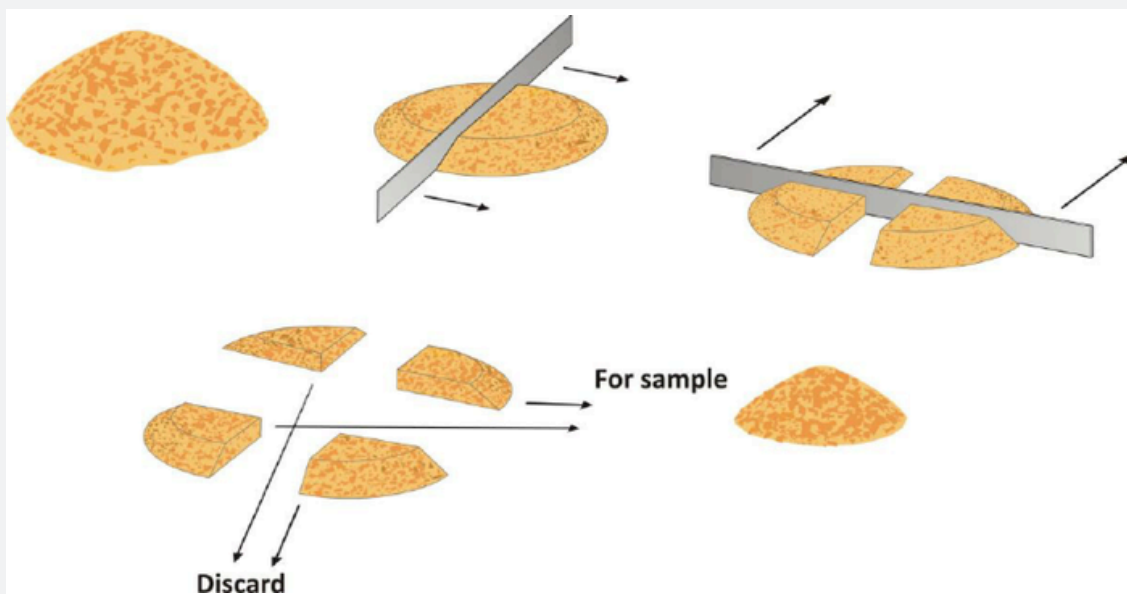
## Obtaining the test sample

1. Put all the samples taken from the different bags or points of the bag into one container.
  2. Mix thoroughly, and then subdivide to obtain the final sample required for analysis.
- A sample divider like the one shown below (Figure 3) may be used to subdivide that sample



**Figure 4.** Box sample divider.



- If a sample divider is not available, use the “quartering method”. Empty the sample on a flat surface to form a cone, and then subdivide by quartering as shown in figure 5 below.

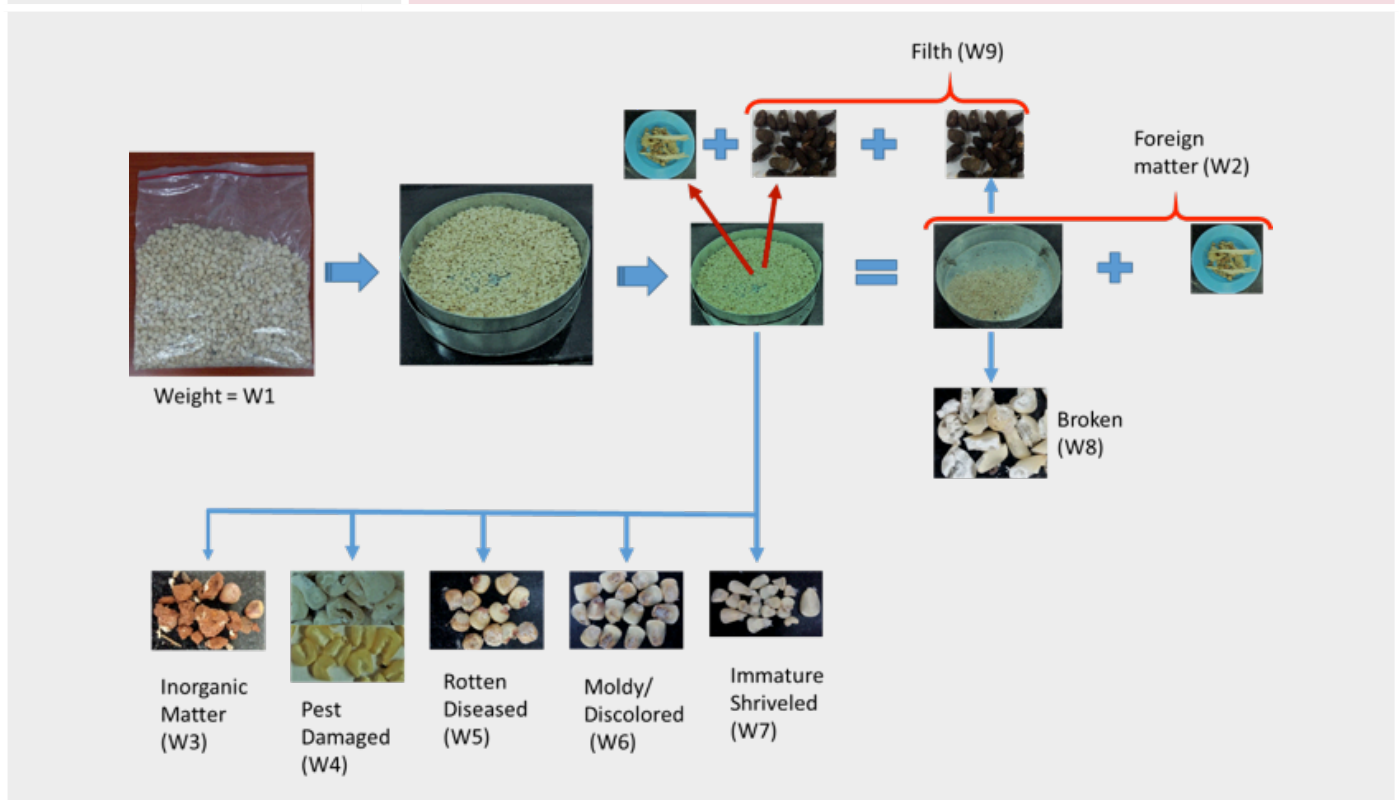


**Figure 5.** Quartering method.

# Sample analysis

**Table 4.** The procedures and parameters for maize sample analysis.

Parameter	Procedure
<b>Moisture content</b> Bottle and salt method 	<ol style="list-style-type: none"> <li>1. Take a random sample from the grain lot.</li> <li>2. Fill the sample halfway into a glass bottle</li> <li>3. Add 2 teaspoons of dry salt (<i>the salt should be dried on a pan over a fire for 15 minutes before use</i>).</li> <li>4. Shake the mixture for 2 minutes.</li> <li>5. Wait for 20 minutes</li> <li>6. Pour out the mixture.</li> <li>7. Check for salt clinging on the walls of the glass.</li> <li>8. If salt is found on the walls of the bottle, the maize is not dry.</li> </ol>
DryCard indicator Method 	<ol style="list-style-type: none"> <li>1. Get a dry clear glass or plastic container with a lid</li> <li>2. Fill the container halfway with a sample of the maize.</li> <li>3. Place the DryCard™ indicator above the maize grains and close the lid tightly.</li> <li>4. Wait for 20 minutes.</li> <li>9. Examine color of the paper strip; (<i>the color changes from blue to purple to pink depending on the grain moisture</i>).</li> <li>5. If color of the strip turns bright pink (above the black line mark) the maize is not dry for safe storage..</li> </ol>
Foreign odor	<ol style="list-style-type: none"> <li>1. Take a random sample in the hand and smell. The smell should be typical of maize without other odors e.g. chemicals, moldiness, earth, rotten, musty smell etc.</li> </ol>



Foreign matter	<ol style="list-style-type: none"> <li>1. Obtain a sample of about 1 kilogram.</li> <li>2. Divide the sample to obtain a sub-sample of about 200 grams.</li> <li>3. Weigh the sub-sample and record the weight (W1)</li> <li>4. Sieve the sub-sample by placing in a 4.5 mm screen and shaking it.</li> <li>5. Collect the material that goes through the sieve. Also collect other loose matter that is retained on the sieve, and weigh these together (W2)</li> <li>6. Calculate the percentage foreign matter as: <math>(W2/W1) \times 100</math>.</li> </ol>
Inorganic matter	Pick any metallic pieces, stones, plastics, glass, sand, etc. from the grain retained on the sieve and weigh (W3). Calculate the percentage inorganic matter as: $(W3/W1) \times 100$ .
Pest damaged grains	Pick all insect and rodent damaged grains on the maize retained on the sieve and weigh (W4). Calculate the percentage inorganic matter as: $(W4/W1) \times 100$ .
Rotten and diseased grain	Pick all rotten and diseased grains on the maize retained on the sieve and weigh (W5). Calculate the percentage inorganic matter as: $(W5/W1) \times 100$ .
Moldy/ discolored grains	Pick all moldy and discolored grains on the maize retained on the sieve and weigh (W6). Calculate the percentage moldy/ discolored grain as: $(W6/W1) \times 100$ .
Immature/ shriveled grains	Pick all the shriveled grains on the maize retained on the sieve and weigh (W7). Calculate the percentage shriveled grains as: $(W7/W1) \times 100$ .
Broken grains	Pick all the whole and broken grains that passed through the sieve and weigh (W8). Calculate the percentage broken grains as: $(W8/W1) \times 100$ .
Filth	Pick impurities of animal origin that went through the sieve, and those that remained on top and weigh (W9). Calculate the percentage filth as: $(W9/W1) \times 100$ .

## Further readings

1. EAC (2013) East African Standard - EAS 2:2013, ICS 67.060: Maize grains — Specification (Third Edition).
2. Gwinner, J, Harnisch, R., & Muck, O. (1996). Manual of the prevention of post-harvest grain losses. Deutsche Gesellschaft für Technische Zusammenarbeit (GTZ) GmbH, 338 pp.

This manual was made possible with support from the American people delivered through the United States Agency for International Development (USAID) as part of the US Government's Feed the Future Initiative. The contents are the responsibility of the International Institute of Tropical Agriculture (IITA) and do not necessarily reflect the opinion of USAID or the U.S. Government.